

RoHS Compliant Product

A suffix of "-C" specifies halogen or lead -free

## DESCRIPTION

The SM86XX series are a group of positive voltage regulators manufactured by CMOS technologies with low power consumption and low dropout voltage, which provide large output currents even when the difference of the input-output voltage is small.

The SM86XX series can deliver 250mA output current and allow an input voltage as high as 45V. The series are very suitable for the battery powered equipment, such as RF applications and other systems requiring a quiet voltage source.

## FEATURES

- Internal Short-Circuit Current Limiting
- Internal Thermal Overload Protection
- No External Components Required

## PACKAGE INFORMATION

Package	MPQ	Leader Size
SOT-89	1K	7 inch

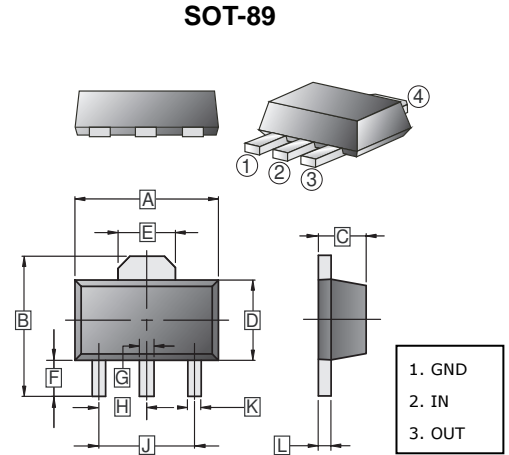

REF.	Millimeter		REF.	Millimeter	
	Min.	Max.		Min.	Max.
A	4.40	4.60	G	0.40	0.58
B	3.94	4.25	H	1.50 TYP.	
C	1.40	1.60	J	3.00 TYP.	
D	2.25	2.60	K	0.32	0.52
E	1.50	1.85	L	0.35	0.44
F	0.89	1.20			

## DEFINITION INFORMATION

Part Number	Output Voltage	Marking
SM8633	3.3V	8633
SM8636	3.6V	8636
SM8650	5V	8650
SM86120	12V	86120

## ABSOLUTE MAXIMUM RATINGS (Unless otherwise specified, $T_A=25^\circ\text{C}$ )

Parameter	Symbol	Ratings	Unit
Input Voltage <sup>2</sup>	$V_{IN}$	-0.3~50	V
Output Voltage <sup>2</sup>	$V_{OUT}$	-0.3~12	V
Output Current	$I_O$	250	mA
Power Dissipation	$P_D$	0.6	W
Operating Ambient Temperature	$T_A$	-40~85	°C
Lead Temperature(Soldering, 10 sec)	$T_{solder}$	260	
Operating Junction Temperature Range <sup>3</sup>	$T_J$	-40~125	
Storage Temperature Range	$T_{STG}$	-40~125	

Notes:

1. Stresses beyond those listed under absolute maximum ratings may cause permanent damage to the device. These are stress ratings only, and functional operation of the device at these or any other conditions beyond those indicated under recommended operating conditions is not implied. Exposure to absolute-maximum-rated conditions for extended periods may affect device reliability.
2. All voltages are with respect to network ground terminal.
3. This IC includes over temperature protection that is intended to protect the device during momentary overload. Junction temperature will exceed 125°C when over temperature protection is active. Continuous operation above the specified maximum operating junction temperature may impair device reliability.

**TYPICAL APPLICATION**

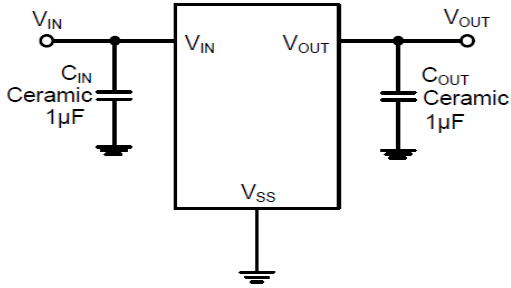

**BLOCK DIAGRAM**

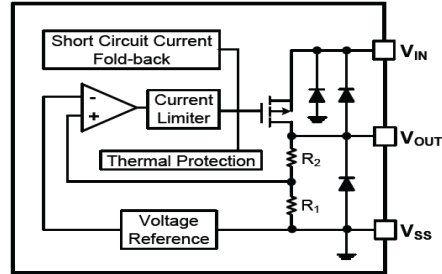

**RECOMMENDED OPERATING CONDITIONS**

Parameter	Rating	Unit
Supply Voltage @VIN	2.5~45	V
Operating Junction Temperature Range, Tj	-40~125	°C
Operating Free Air Temperature Range, TA	-40~85	°C

**ELECTRICAL CHARACTERISTICS** (VIN=VOUT+2V, CIN=COUT=1µF, TA=25°C, unless otherwise specified)

Parameter	Symbol	Test Condition	Min.	Typ. <sup>1</sup>	Max.	Unit	
Input Voltage	VIN		2.5	-	45	V	
Output Voltage Range	VOUT		2.1	-	12	V	
DC Output Accuracy		IOUT=10mA	-2	-	2	%	
			-1	-	1		
Dropout Voltage <sup>2</sup>	Vdif	IOUT=100mA, VOUT=3.3V	-	700	-	mV	
Supply Current	ISS	IOUT=0A	-	2	10	µA	
Line Regulation	$\frac{\Delta V_{OUT}}{V_{OUT} \times \Delta V_{IN}}$	IOUT=10mA VOUT 1V ≤ VIN ≤ 36V	-	0.01	0.3	%/V	
Load Regulation	ΔVOUT	VIN=VOUT 2V, 1mA ≤ IOUT ≤ 100mA	-	8	-	mV	
Temperature Coefficient	$\frac{\Delta V_{OUT}}{V_{OUT} \times \Delta T_A}$	IOUT=40mA, -40°C < TA < 85°C	-	50	-	ppm	
Output Current Limit	ILIM	VOUT=0.5*VOUT(Normal)	-	260	-	mA	
Short Current	ISHORT	VOUT=VSS	-	30	-	mA	
Power Supply Rejection Ratio	PSRR	IOUT=50mA	100Hz	-	80	-	dB
			1kHz	-	70	-	
			10kHz	-	60	-	
			100kHz	-	50	-	
Output Noise Voltage	VON	BW=10Hz~100kHz	-	27* VOUT	-	µVRMS	
Thermal Shutdown Temperature	TSD	ILOAD=30mA	-	160	-	°C	
Thermal Shutdown Hysteresis	ΔTSD		-	20	-	°C	

Notes:

- Typical numbers are at 25°C and represent the most likely norm.
- Vdif: The difference of output voltage and input voltage when input voltage is decreased gradually till output voltage equals to 98% of Vout.

**CHARACTERISTICS CURVE**

**Output Voltage vs. Temperature**

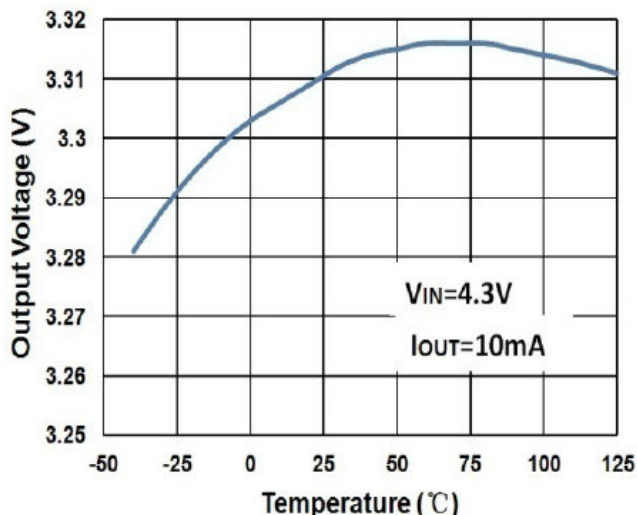

**PSRR vs. Frequency**

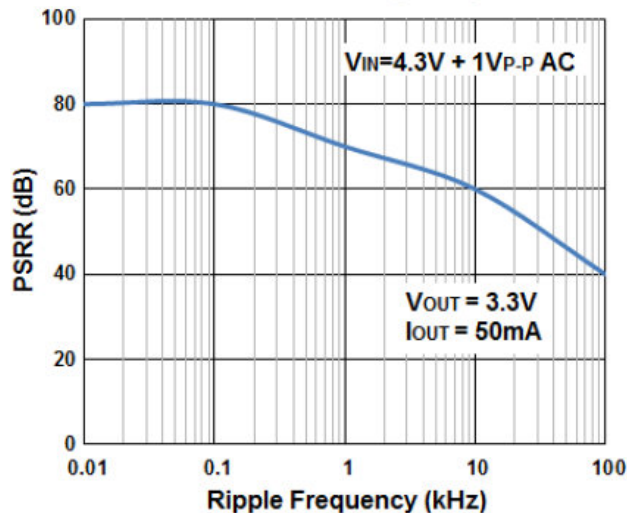

**Load Transient Response**

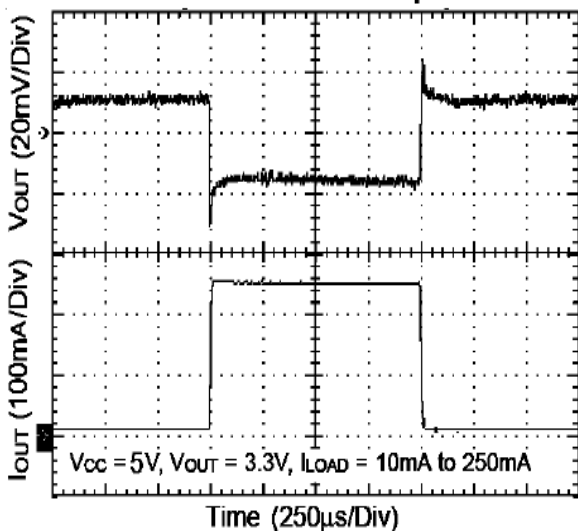

**Line Transient Response**

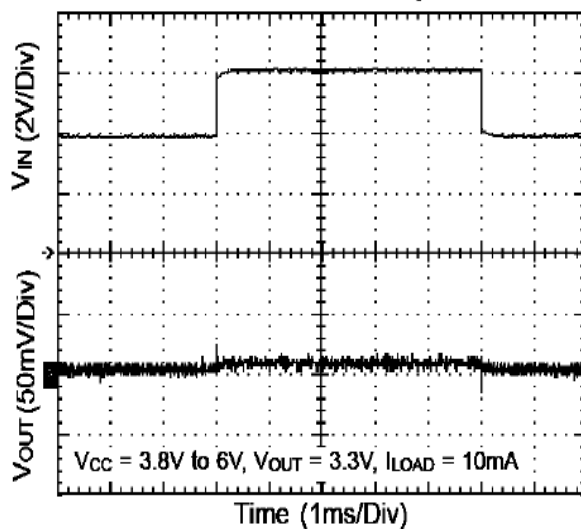

**Power Up Response**

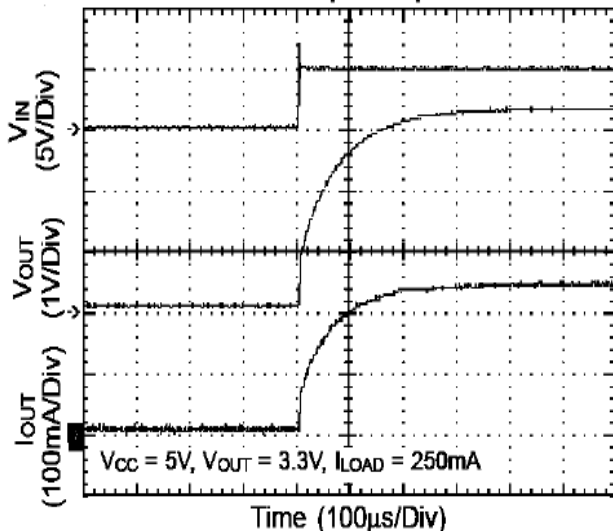

**Output Noise 10Hz to 100kHz**

